

CUSTOMER SIGNATURE:

DATE:

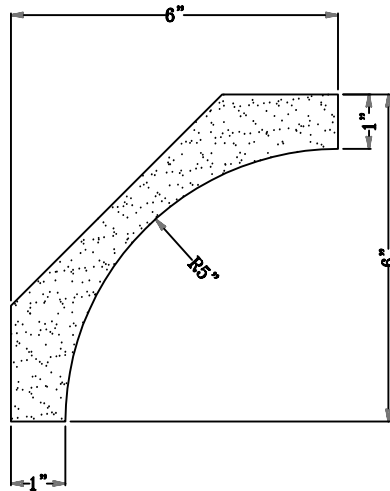

PROFILE

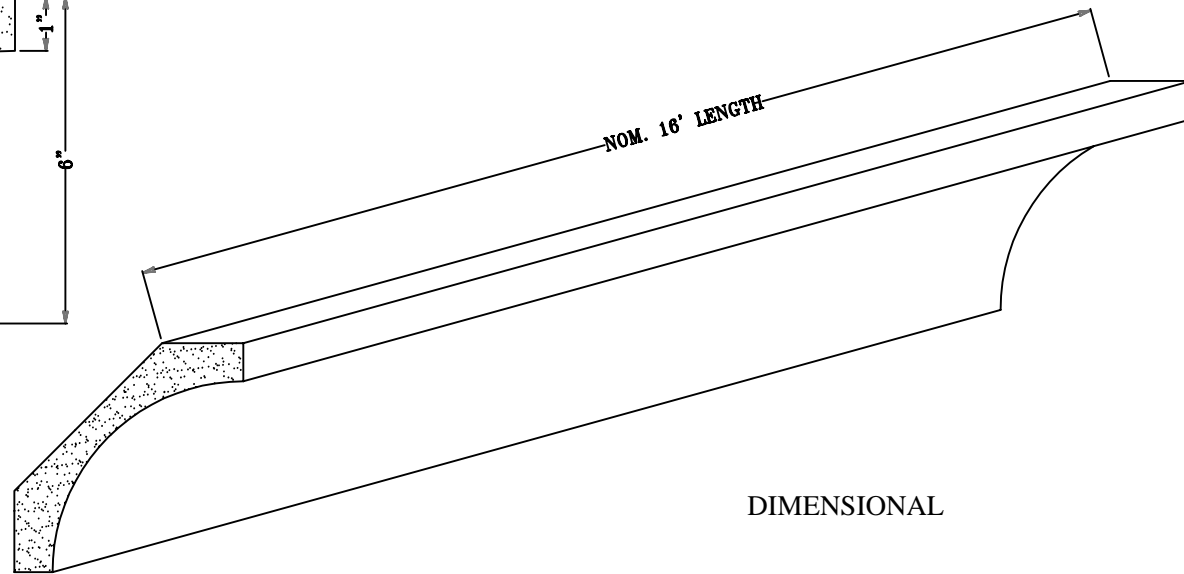

DIMENSIONAL



WORTHINGTON

YOUR ONLY SOURCE FOR FINE ARCHITECTURAL DETAILS

10175 FORTUNE PARKWAY, SUITE 502
JACKSONVILLE, FL 32256
PHONE: 1-800-872-1608 OR 904-281-1485
FAX: 904-281-1488 WorthingtonMillwork.com

DWG TITLE: COVE MOULDING

PRODUCT NO: 01-262-16

DATE: 28-08-07

DRAWN BY: RZ

DIM. TOLERANCE: N.A.

ALL RIGHTS RESERVED. THIS DRAWING IS THE PROPERTY OF WORTHINGTON GROUP, LTD. AND MAY BE USED ONLY IN CONJUNCTION WITH CONSTRUCTION PROJECTS UTILIZING WORTHINGTON GROUP, LTD. PRODUCTS. THIS DETAIL MAY NOT APPLY TO ALL CONDITIONS OR CONSTRUCTION SITUATIONS. FOR NON-TYPICAL CONDITIONS, CONSULT WORTHINGTON GROUP LTD